











## Standard series Pocket filter Infa-Mat AM - mechanical cleaning

### Explanation

Series 1	Dust collector / Vent filter with fan
Series 2	Dust collector / Vent filter with fan
Series 3	Dust collector / Vent filter without fan
Series 4	Vent filter with or without fan
Series 5	Sack emptying filter with fan
S	Special size
K	Heavy-duty compact filter
D	Secondary filter stage

Filter series			Systematic type key	Dimension sheets
 <p><b>AM ..1 D</b> Dust collector with fan and bottom part, secondary filter stage</p>	 <p><b>AM ..1 S</b> Dust collector with fan and U-profile support frame, special size</p>	 <p><b>AM ..1 S</b> Dust collector with bottom part, special size</p>	<p><b>AM xx 1 x</b> Infa-Mat AM Filter surface (m<sup>2</sup>) Series 1 S / K / D</p>	<p>1010/01.07 <a href="#">download here</a></p> <p>1020/01.07 <a href="#">download here</a></p> <p>1030/01.07 <a href="#">download here</a></p>
 <p><b>AM .. 2</b> Vent filter with fan</p>			<p><b>AM xx 2 x</b> Infa-Mat AM Filter surface (m<sup>2</sup>) Series 2 S / K / D</p>	<p>1011/01.07 <a href="#">download here</a></p>
 <p><b>AM .. 3</b> Dust collector with U-profile support frame</p>	 <p><b>AM .. 3</b> Dust collector with fan and bottom frame</p>	 <p><b>AM..3 K</b> Dust collector with bottom frame</p>	<p><b>AM xx 3 x</b> Infa-Mat AM Filter surface (m<sup>2</sup>) Series 3 S / K / D</p>	<p>1012/01.07 <a href="#">download here</a></p> <p>1040/01.06 <a href="#">download here</a></p>
 <p><b>AM .. 4</b> Vent filter</p>	 <p><b>AM .. 4</b> Vent filter</p>	 <p><b>AM .. 4 D</b> Round filter with secondary filter stage</p>	<p><b>AM xx 4 x</b> Infa-Mat AM Filter surface (m<sup>2</sup>) Series 4 D</p>	<p>1013/01.07 <a href="#">download here</a></p> <p>1016/01.06 <a href="#">download here</a></p>

Filter series	Systematic type key	Dimension sheets
 <p><b>AM ..5</b> Sack emptying filter with fan</p>	<p><b>AM xx 5 x</b> Infa-Jet AM Filter surface (m<sup>2</sup>) Series 5 RF / RFH</p>	<p>1015/01.07 <a href="#">download here</a></p>

## ASSEMBLY SYSTEM

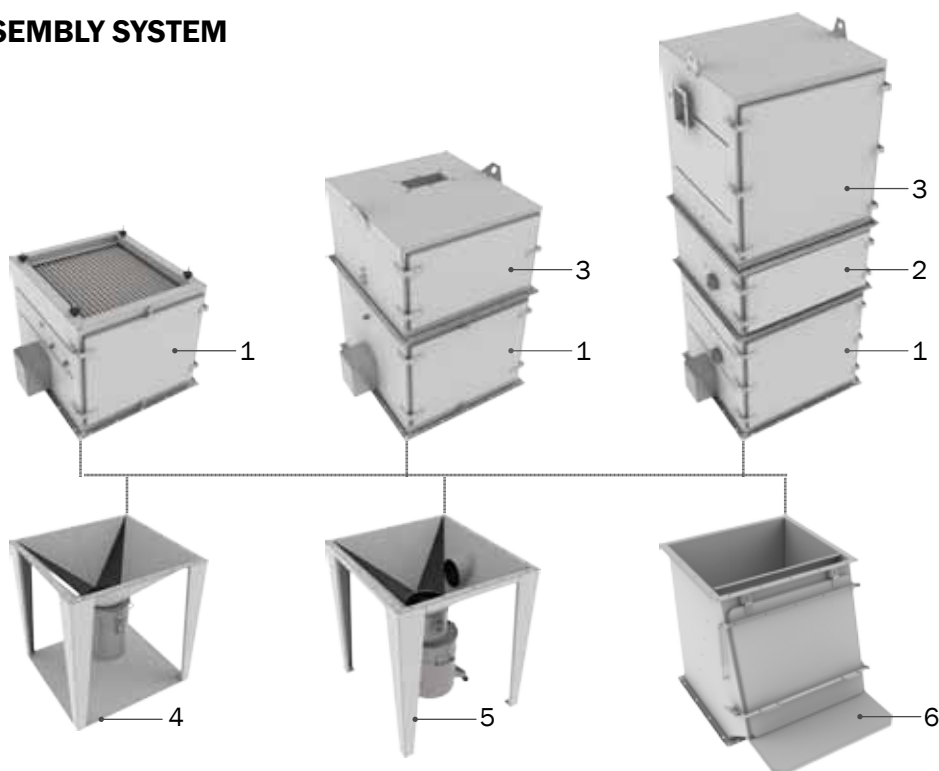

- 1 Filter chamber
- 2 Secondary filter stage
- 3 Fan chamber
- 4 Bottom part with mit ground plate and dust collecting container
- 5 U-profile support frame with dust collecting container
- 6 Sack pouring chute

# INFASTAUB



*Breathe The Difference: Pure Air*

Infastaub GmbH | Niederstedter Weg 19 | D - 61348 Bad Homburg v.d.H.

T. +49 6172 3098-0 | F. +49 6172 3098-90

infa@infastaub.de | www.infastaub.de

Copyright reserved. The entire content, such as text, pictures and graphics is protected by trademark law and copyright and other laws for the protection of intellectual property. Any use of the contents is only permitted with prior consent of Infastaub GmbH. All information, descriptions and illustrations are subject to technical modification, especially with regard to further development of our products on the respective state-of-the-art of technology. Changes of information, descriptions and illustrations are without making special notification.

Mistakes and errors reserved.

2020©Infastaub  
BR.02.EN.11.20